

Varenummer: 03553040

Beskrivelse: Fluro hydraulik ledhoved FPR 40U

Mål

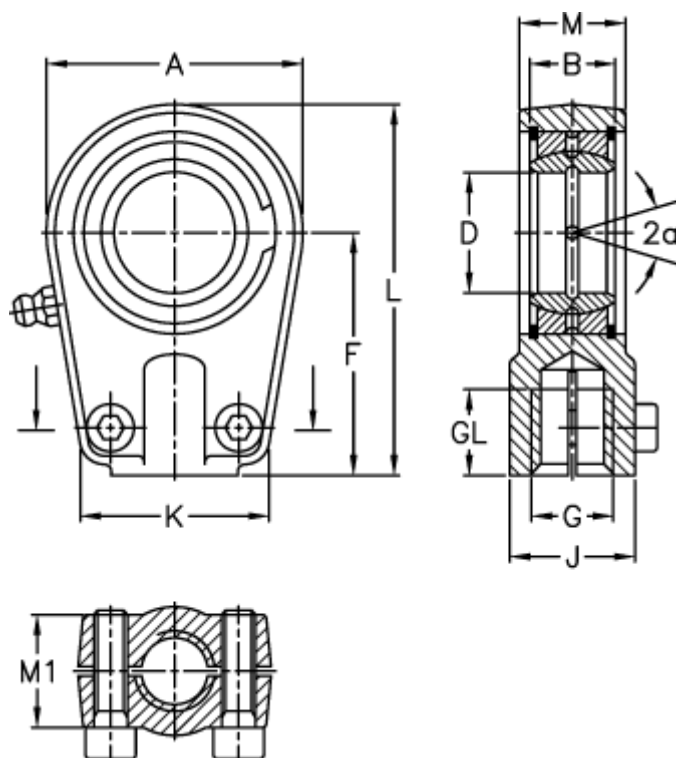

A	= 94	J	= 49
a (grader)	= 7	K	= 76
B	= 28	L	= 135
D	= 40	M	= 35
Dynamisk belastning C (kN)	= 100	M1	= 33
F	= 85	Moment (Nm)	= 49
g	= M35x1,5	Statisk belastning C0 (kN)	= 250
GL	= 36	Vægt	= 2075